



**AUSTRALIAN 'WORLD RULES'  
FOR  
BRP-ROTAX  
FR 125 JUNIOR MAX  
TECHNICAL SPECIFICATIONS**



VERSION 3 / 2012  
UPDATED JANUARY 23<sup>rd</sup>, 2012





## BRP-ROTAX FR 125 JUNIOR MAX TECHNICAL SPECIFICATIONS

### Preamble:

The following are the Technical Specifications for the BRP-ROTAX FR 125 JUNIOR MAX engine, as approved by the Australian Karting Association.

This engine is approved for use in the following classes;

#### FR 125 JUNIOR MAX:

Formula Junior Max

Junior Performance – Must be fitted with an 'AKA JR1' exhaust restrictor with a maximum 26mm hole.

Restricted 125 – Must be fitted with an 'AKA JR1' exhaust restrictor with a maximum 26mm hole.

**Unless otherwise specified, the engines must be original in all their components according to the ROTAX FR 125 JUNIOR MAX drawings.**

**Any removal, addition or polishing of material is strictly forbidden.**

Sandblasting, glass bead blasting, peening, acid etching, spark eroding and/or any other method of metal removal or displacement is not allowed.

The use of thermal barrier coatings/ceramic coatings on or in the engine and on or in the exhaust system is prohibited.

The use of anti-friction coatings in or on the engine/engine components is prohibited.

**The only exceptions to this are the glnisil coating of the cylinder bore and the coating to the piston skirt.**

Customizing the cylinder head cover by painting is legal

**ANY ALTERATIONS / MODIFICATIONS ARE STRICTLY PROHIBITED EXCEPT AS SPECIFICALLY AUTHORISED WITHIN THESE SPECIFICATIONS.**

**IF THESE SPECIFICATIONS DO NOT SAY YOU CAN MAKE A MODIFICATION, THEN YOU CANNOT.**

Neither the engine nor any of its ancillaries may be modified in any way. "Modified" is defined as any change in form, content or function that represents a condition of difference from that originally designed. This is to include the addition and/or omission of parts and/or material from the engine package assembly unless specifically allowed within these rules. The adjustment of elements specifically designed for that purpose shall not be classified as modifications, i.e. carburetor and exhaust valve adjustment screws.

**Genuine ROTAX components only, that are specifically designed and supplied for the FR 125 JUNIOR MAX engine are legal, unless otherwise specified.**

**ANYTHING WHICH IS NOT EXPRESSILY ALLOWED IN THE TECHNICAL REGULATIONS IS FORBIDDEN.**

**FOR USE IN AUSTRALIAN RACING, EVERY ENGINE MUST HAVE THE OFFICIAL FORMULA ROTAX AUSTRALIA STAMP ON THE CRANKCASE & ALSO ON THE REED BLOCK FACE OF THE CYLINDER.**

### Internal additions:

No additional material may be added except in the case of engine repairs and shall only restore the engine or components to original specifications.

### Legal additions:

Chain guard, engine mount, temperature gauge and tachometer/hour meter, inline fuel filter, catch can mounting brackets and supplemental ignition coil mounting brackets, within the limits specified in this document.

### Non-tech items:

Battery, Fuel Filter, Radiator Hoses, Clamps, Pulse Line, Switches, Ancillary Mounts, Fasteners, Circlips, Washers, Bearings, Spark Plugs, Gaskets, O-Rings, Piston Pin, Springs, Seals, Clutch Drum, Engine Sprocket, Rings, Starter Motor, Clutch Flywheel, Thermostats and Housings, unless otherwise specified. Clutch Drum Evolution (AKA #48 approved Part ID #659154)



### Note:

When taking any dimensional reading, of the following technical regulation, in the order of accuracy of 0,1 mm or even more precise, the temperature of the part must be between +10°C and +30°C.



It is the responsibility of the competitor to check his equipment (all components outside the engine seal and mentioned below), to assure that his equipment is in line with the technical specification below!

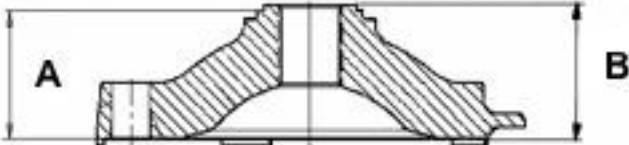

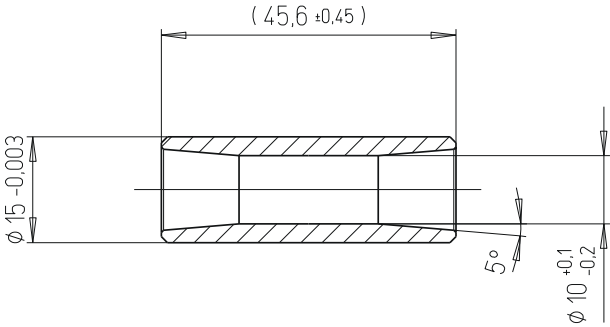

## BRP-ROTAX FR 125 JUNIOR MAX TECHNICAL SPECIFICATIONS

<b>Technical Specification (within the engine seal) for ROTAX kart engine FR 125 JUNIOR MAX (15 kW)</b>		
Squish gap	1.1 1.2	FR 125 JUNIOR MAX 1.20 mm – 1.80 mm The squish gap must be measured with a certified slide gauge and by using a 2 mm tin wire. The crankshaft must be turned by hand slowly over TDC (top dead center) to squeeze the tin wire. The squish gap must be measured on the left and right side in the direction of the piston pin. The average value of the two measurements counts. Recommended 2mm tin wire : part no. 580 130
Combustion chamber insert	2.1 2.2  2.3  2.4	<p>Cast identification code has to be "223 389" or "223 389 1" or "223 389 2" Casted wording "ROTAX" and/or "MADE IN AUSTRIA" must be shown.</p> <div style="text-align: center;">  </div> <p>Heights of combustion chamber insert have to be 27.55 mm with a tolerance of +0.0/-0.1 mm (A) and 28.80 mm with a tolerance of +/- 0.2 mm (B).</p> <div style="text-align: center;">  </div> <p>The profile of the combustion chamber insert has to be checked with a template (ROTAX part no. 277 390). The crack of light between the template and the profile of the combustion chamber insert has to be the same over the whole profile.</p> <div style="text-align: center;">  </div> <p><b>NOTE:</b> This check is just for reference. In case of doubt detailed measurements have to be performed to define conformity or non conformity.</p>
Piston with ring assy.	3.1  3.2	<p>Original, coated or uncoated, aluminium, cast piston with one piston ring. The piston has to show on the inside the cast wording "ELKO" (1) and "MADE IN AUSTRIA" (2).</p> <div style="text-align: center;">  </div> <p>Machined areas are: Top end of piston, outside diameter, groove for the piston ring, bore for the piston pin, inside diameter at bottom end of piston and some pre-existing factory removal (3) of flashing at the cut out of the piston skirt. All other surfaces are not machined and have cast surface.</p>



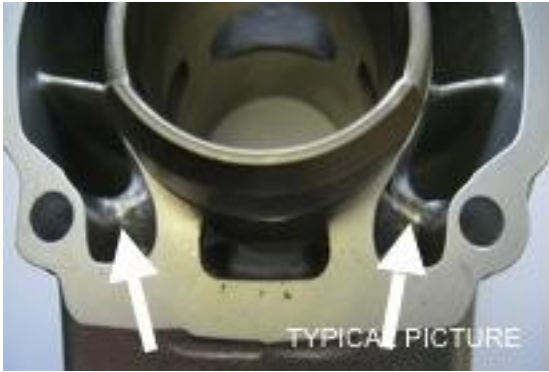

## BRP-ROTAX FR 125 JUNIOR MAX TECHNICAL SPECIFICATIONS

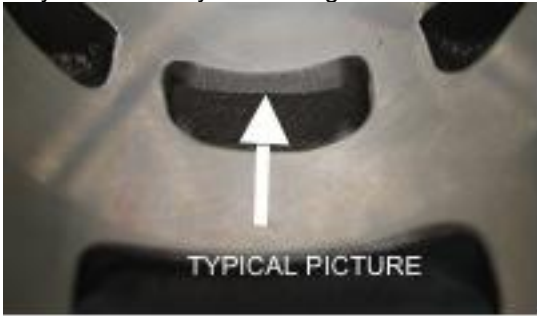
	3.3	<p>Original, 1 mm, magnetic, rectangular piston ring. Piston ring is marked either with "E CRY K" or "ROTAX 215 547" or "<u>ROTAX 215 548</u>".</p> <div style="text-align: center;">  </div>
Gudgeon pin	4.1 4.2 4.3	<p>Gudgeon pin is made out of magnetic steel.          Dimensions must be according to the drawing.          The minimum weight of the gudgeon pin must not be lower than 32,10 grams.</p> <div style="text-align: center;">  </div>
Cylinder	5.1 5.2 5.3 5.4  5.5	<p>Light-alloy-cylinder with GILNISIL-plating. Any re-plating of cylinder is not allowed.          Cylinder with one main exhaust port.          Maximum bore of cylinder = 54.035 mm (measured 10 mm above the exhaust port)          Cylinder has to be marked with the "ROTAX" logo (see pictures below).</p> <p><b>FR 125 JUNIOR MAX</b>          Cylinder without pneumatic timed exhaust valve. Cylinder has to be marked either with identification code;</p> <div style="display: flex; justify-content: space-around; align-items: center;"> <div style="text-align: center;">223 998</div> <div>OR</div> <div style="text-align: center;">223 994</div> </div> <div style="display: flex; justify-content: space-around; align-items: center; margin-top: 10px;">   </div>

## BRP-ROTAX FR 125 JUNIOR MAX TECHNICAL SPECIFICATIONS

	<p>5.6 Height of cylinder has to be 87 mm - 0.05/+0.1 mm.</p>  <p>5.7.1 All transfer ports and passages have cast finish surface except some removal (done by the manufacturer) of cast burr at the inlet passage. and exhaust port and passages. All ports have chamfered edges to prevent ring snagging. Any additional machining is not permitted. The top edge of exhaust port may show some pre-existing machining from the manufacturer. The sealing flange for the exhaust socket may show signs of machining from the manufacture.</p>  <p style="text-align: center;">TYPICAL PICTURE</p>
	<p>5.7.2 All ports have chamfered edges. Any additional machining is not permitted.</p>  <p>On cylinders marked 223 993 and 223 994 the upper edge of the central boost port may show factory machining.</p>  <p style="text-align: center;">TYPICAL PICTURE</p>

## BRP-ROTAX FR 125 JUNIOR MAX TECHNICAL SPECIFICATIONS

	5.7.3	<p>The sealing flange for the exhaust socket may show either cast finish surface or signs of machining from the manufacturer.</p> 
	5.7.4	<p>The top edge of the exhaust port may show either just a cast finish surface...</p>  <p>or signs of a CNC machining ...</p>  <p>or signs of CNC machining in combination with signs of manual grinding.</p>  <p>The exhaust port may show partial manual grinding done by the manufacturer to eliminate minor casting defects and to eliminate the NIKASIL burr at the end of the NIKASIL plating.</p>
		<p>At cylinders 223 994, the exhaust port may show factory machining all around.</p> 

## BRP-ROTAX FR 125 JUNIOR MAX TECHNICAL SPECIFICATIONS

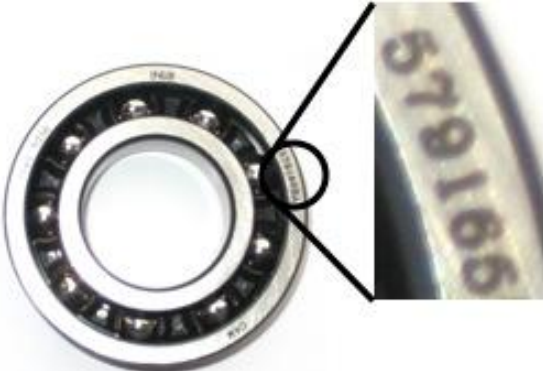
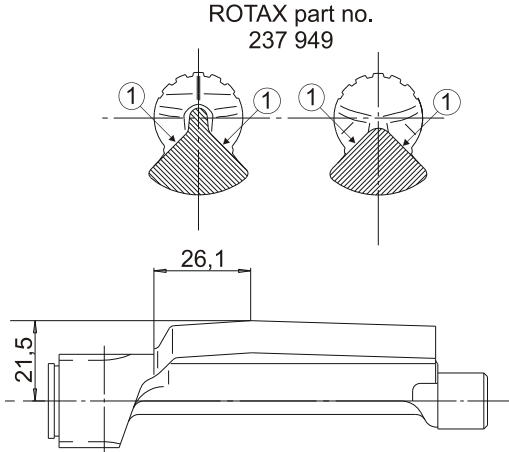

	5.8	<p><b>Exhaust port timing</b></p> <p>The "exhaust port timing" (distance from the top of the cylinder to the top of the exhaust port) has to be checked by means of the template (ROTAX part no. 277 397)</p> <p>Insert the template into the cylinder, that the template is touching the cylinder wall and that the finger of the template is located in the middle of the exhaust port (highest point).</p> <p>Move the template upwards, until the finger is touching the top edge of the exhaust port. Insert a filler gauge between the top of the cylinder and the template. It must not be possible to fit the feeler gauge specified below.</p> <p><b>FR 125 JUNIOR MAX:   0,90 mm for cylinder 223 998                                   1,10 mm for cylinder 223 994</b></p> <p>NOTE: Take care to use the corresponding gauge(JUN or MAX) of the template for the respective cylinder!</p> <div data-bbox="523 698 1074 1115" data-label="Image"> </div>
Inlet system	6.1	<p>Inlet manifold is marked with the name "ROTAX" and the identification code "267 915"</p> <div data-bbox="475 1227 1026 1727" data-label="Image"> </div> <p>6.2</p> <p>6.3</p> <p>6.4</p> <p>Some factory flash removal may be present at the conjunction of the inside contour and the carburetor stop mounting face. This is a manual trimming operation consisting of a small corner break of less than 3 mm in width. No additional grinding or machining is permitted.</p> <p>The reed valve assy is equipped with 2 pedal stops and 2 reeds, each having 3 pedals.</p> <p>The thickness of the reeds is 0,6 mm +/- 0,08 mm.</p>

## BRP-ROTAX FR 125 JUNIOR MAX TECHNICAL SPECIFICATIONS



<p>Crankshaft</p>	<p>7.1 7.2   7.3  7.4</p>	<p>Stroke 54.5 mm +/-0.1 mm Con rod has to show forged numbers "213", "365" or "367" on shaft.</p>  <p>Shaft of con rod is not machined (copper plated). Grinding or polishing of shaft of con rod is not permitted.</p> <p>Effective from 1st June 2012 crankshaft main bearing 6206 from FAG only is allowed for the Rotax National Championships, Rotax Pro Tour, all State Championships and events where Rotax is run as a standalone class. This does not apply to Restricted TAG, TAG &amp; Sportsman style classes. (must be marked with code <b>579165BA</b> or Z-579165.11.KL)</p> 
<p>Balance shaft</p>	<p>8.1 8.2 8.3 8.4 8.5</p>	<p>Balance shaft and balance gears must be installed. Configurations of part no. 237 949 (equal with 237 948) only is legal. Surface (1) is not machined and must show cast surface. Measurement from center of balance shaft to outer diameter of fly weight of balance shaft at defined length must not be lower than specified. The minimum weigh of the dry balance shaft must not be lower than:- 255 grams for balance shaft ROTAX part no. 237 949 (equal with 237 948).</p> <p style="text-align: center;">ROTAX part no. 237 949</p> 
<p>Crankcase</p>	<p>9.1</p>	<p>As supplied by the manufacturer. No grinding/polishing is permitted in the two main transfer passages as well as in the crank area.</p>

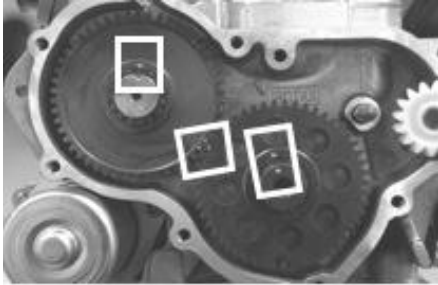

## BRP-ROTAX FR 125 JUNIOR MAX TECHNICAL SPECIFICATIONS

<b>Technical Specification (outside the engine seal) for ROTAX kart engines FR 125 JUNIOR MAX (15 kW)</b>		
It is the responsibility of the competitor to check his equipment (all components outside the engine seal and mentioned below), to assure that his equipment is in line with the technical specification below!		
Balance drive	10.1	<p style="color: red;">Only steel balance gears are legal to be used at the Rotax National Championships, Rotax Pro Tour, all State Championships and events where Rotax is run as a standalone class. Other events can continue to use the old style plastic balance gears.</p>  <p>Balance gears must be installed and must be aligned according to the instruction in the repair manual.</p> <p>Mixing of steel balance gears of different width (6.0 and 9.0 mm) is strictly forbidden.</p>
	10.2	
	10.3	<p style="color: red;">Balance drive gear compartment must be vented and connected to a minimum 100ml plastic overflow bottle via plastic hose.</p>
Ignition System	11.1	<p style="color: red;">DENSO digital battery ignition, variable ignition timing, no adjustment necessary and possible. Race officials may request at any time that the competitor replace the ignition coil with a new unit provided by the race administration.</p>
	11.2	<p style="color: red;">The casting of the ignition coil has to show the following in casting "129000-" and "DENSO".</p>
	11.3	<p style="color: red;">Ignition coil must show 3 pins at the terminal.</p>
	11.4	<p style="color: red;">Connector housing of ignition coil must have either black or green color.</p>
	11.5	<p style="color: red;">The ignition coil has to be fixed by means of 2 original silent blocks to the gearbox cover. Only in case of chassis component interference with the original mounting location of the ignition coil, a supplementary extension bracket, rigidly constructed and fabricated of solid metal, of minimum dimensions and attached to the original case mounting holes, is permitted for mounting of the coil.</p>
	11.6	<p style="color: red;">Minimum length of ignition wire (high tension wire) is 210 mm from outlet of cable at ignition coil to outlet of cable at spark plug connector ( = the visible length of wire ) Ignition coil must be in working condition ( to be tested in case of doubt)</p>
	11.7	<p style="color: red;">The pick up must be marked with the numbers 029600- 0710, followed by a variable production code in the 2nd line.  HINT: In case of doubt an easy check is to place a steel ball (3-5 mm in diameter) on the pickup (engine side), the steel ball must stay in the center of the pickup surface.</p>
	11.8	<p style="color: red;">Spark plug cap must be marked with "NGK TB05EMA".</p>
	11.9	<p style="color: red;">Battery must be fitted to the chassis with at least 2 screws. Position of the battery is free.</p> 

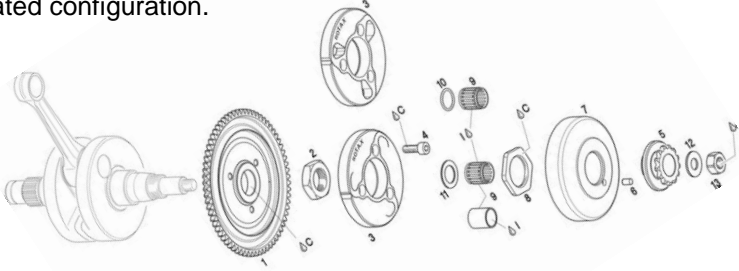
## BRP-ROTAX FR 125 JUNIOR MAX TECHNICAL SPECIFICATIONS

<p>Centrifugal clutch</p>	<p>13.1</p>	<p>Dry centrifugal clutch, engagement maximum at 4.000 r.p.m.</p> <p>That means, that the kart (without driver) must start to move latest at an engine speed of maximum 4.000 r.p.m.</p> <p>There are two versions of the clutch shoe (element part # 3 on the diagram) and both are legal to be used. The older version of the clutch shoe can be either untreated or nitrated configuration.</p> 
	<p>13.2</p>	<p>Engines must be fitted with the new needle cage bearing 15x19x17 (item 9) as well as new O-Ring 12 x 2.5 (item 10) only.</p> <p>Except if the plain bearing 15x17x20 (item 9) designed for 11teeth sprocket is used, in this case no O-ring must be used.</p> <p>No extra lubrication or additional substance allowed inside the clutch drum additional to the grease that originates from lubrication of the needle cage bearing and enters the clutch area.</p>  <p>Picture shows worst case scenario in case grease exits the bearing area even O-Ring is installed.</p> <p>Only fixation nut as well as inside of drum show signs of grease, running surface of clutch is completely dry.</p> <p>In case Plain bearing for 11teeth sprocket is used clutch area must be absolutely free grease or any additional substance.</p>

## BRP-ROTAX FR 125 JUNIOR MAX TECHNICAL SPECIFICATIONS

13.3 Steel clutch (both versions) and clutch drum must be within the following specifications.

13.3.1 **Height of clutch**

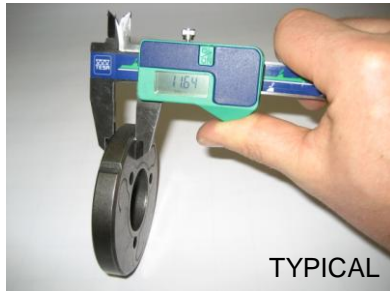

Minimum: 11.45 mm.

13.3.2 **Thickness of clutch shoe**



Measurement has to be done at the 3 open ends of the clutch shoes, 5 - 10 mm from the machined groove (all clutch shoes must be completely closed at measurement - no gap).

No measurement may be below 24.10 mm.

13.3.3 **Outer diameter of clutch drum**

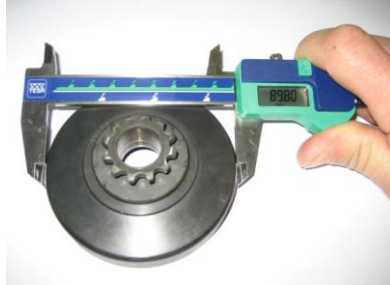

Diameter has to be measured with a sliding caliper just beside the radius from the shoulder (not at the open end of the clutch drum).

Minimum diameter: 89.50 mm.

13.3.4 **Inner diameter of clutch drum**



The inner diameter has to be measured with a sliding calliper. The measurement has to be done in the middle of the clutch drum (in the contact area of the clutch drum).

Maximum diameter: 84,90 mm.

## BRP-ROTAX FR 125 JUNIOR MAX TECHNICAL SPECIFICATIONS

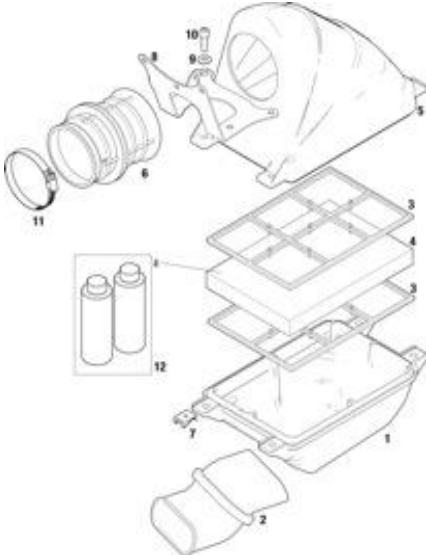
	<p>13.3.5</p> <p>13.3.6</p>	<p><b>Height of sprocket with clutch drum assembly.</b></p>  <p>Minimum height: 33,90 mm  <b>The original Rotax clutch (3 spring type) is eligible to be used until further notice at any event.</b></p>
<p>Intake silencer</p>	<p>14.1</p> <p>14.2</p> <p>14.3</p> <p>14.4</p> <p>14.5</p>	<p>Intake silencer with integrated, washable air filter has to be used with all parts as shown at illustration and has to be mounted on the support bracket with two screws (in dry and wet race condition).</p>  <p>Intake silencer case bottom is marked on the inside with the ROTAX part no. 225 015.          Intake silencer case, top is marked on the inside with the ROTAX part no. 225 025.          Air filter must be installed as shown in illustrations above.</p> <p><b>The original square type intake silencer is not eligible to be used for the Rotax National Championships, Rotax Pro Tour, all State Championships and events where Rotax is run as a standalone class. It can be used in Restricted TAG, TAG &amp; Sportsman style classes.</b></p>

## BRP-ROTAX FR 125 JUNIOR MAX TECHNICAL SPECIFICATIONS

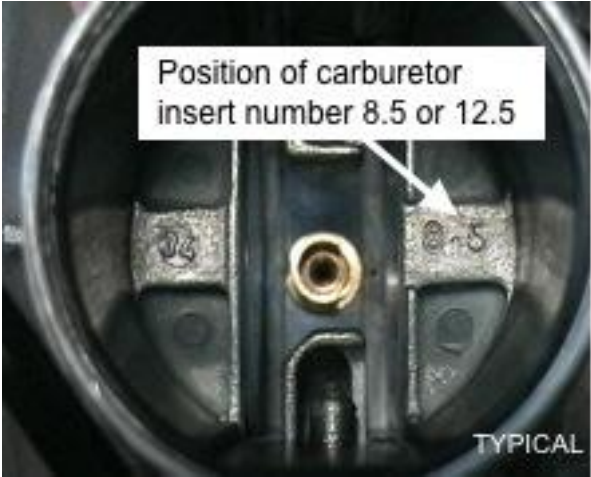
<p>Carburetor</p>	<p>15.1 15.2 15.3 15.4 15.5 15.6 15.7 15.8 15.8.1 15.8.2  15.9 15.10 15.11 15.12 15.13</p>	<p>DELL'ORTO carburetor</p> <p>VHSB 34" cast in the housing of the carburetor.</p> <p>"QD" or "QS" stamped in the housing of the carburetor.</p> <p>Needle jet stamped with "FN 266"</p> <p>The complete inlet bore in the casting of the carburetor must show cast surface.</p> <p>The carburetor slide must show with size "40" in casting and the bottom end of the slide must show cast surface.</p> <p>Jet needle stamped with "K98" only</p> <p>Following two combination of floats and idle jets are legal:</p> <p><u>Combination 1:</u> Floats are marked with "gr 5.2" Idle jet is stamped with the digits "30" Idle jet insert is stamped with digits "30" Carburetor insert 12.5 ( see illustration)</p> <p><u>Combination 2:</u> Floats are marked with "gr 3.6" Idle jet is stamped with the digits "60" Idle jet insert is stamped with digits "60" Carburetor insert 8.5 ( see illustration)</p>  <p><u>Needle valve is stamped "150"</u></p> <p>Start jet is stamped with digits "60"</p> <p>Settings of the carburetor adjustment screws are free.</p> <p>A minimum required size of main jet may be determined for each race event by a "Supplementary Regulation".</p> <p><b>Float carburetors must have a catch tank (minimum 150ml) included in the carburetor vent system to catch surplus fuel in the event of the carburetor flooding, as per rule 22.05 of the AKA Manual.</b></p>
<p>Fuel pump</p>	<p>16.1</p>	<p><b>The original MIKUNI Fuel Pump (diaphragm type) must be used.</b></p>

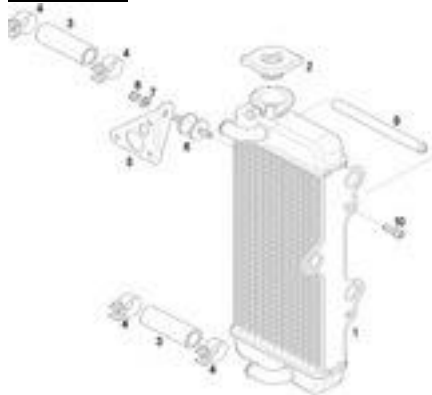
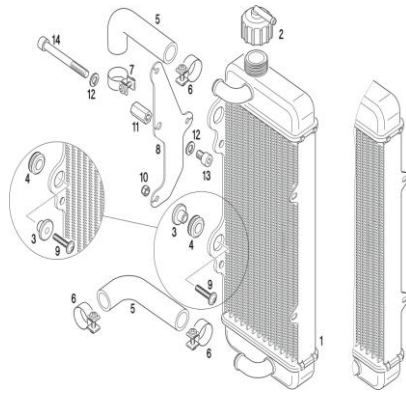
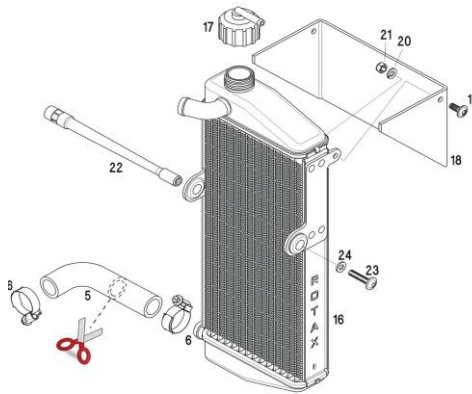

## BRP-ROTAX FR 125 JUNIOR MAX TECHNICAL SPECIFICATIONS

Radiator	18.1	Single aluminium radiator as shown in illustrations Name "ROTAX" stamped in the side of version 3.
	18.2	Version 1/2: Cooling area: Height:290 mm, width:133 mm Version 3: Cooling area: Height:290 mm, width:138 mm
	18.3	Version 1/2: Thickness of radiator = 32 mm Version 3: Thickness of radiator = 34 mm
	18.4	Place of fixing the radiator is on right side of engine.
	18.5	Radiator must be mounted with all components as shown in the illustration either like version 1/2 or like version 3.
	18.6	At version 2 there is 2 legal options to mount the radiator to the retaining plate (see drawing for details) At version 2 there is 2 different radiator with 2 different positions of the retaining plates (either pointing forward or backwards ) No additional non-original cooling device is allowed.
	18.7	For version 1 and 2 tape applied around the radiator is the only allowed air flow control. Tape may not be removed from the radiator during operation on the track. All other means of air flow control through the radiator are prohibited.  For version 3 the original plastic flap is the only way to control the airflow. Removal of the original plastic flap and use of tape, like for the version 1 and 2 of the radiator, is an acceptable configuration.  The removal of the thermostat from the cylinder head cover is an acceptable configuration.
	18.8	<p><u>Version 1</u></p>  <p style="text-align: center;"><u>Version 2</u></p>  <p><u>Version 3</u></p> 

## BRP-ROTAX FR 125 JUNIOR MAX TECHNICAL SPECIFICATIONS

Radiator coolant	19.1 19.2	As glycol coolants are prohibited, plain water without any additives has to be used. <b>Radiator coolant system must be fitted with a catch tank of minimum 100ml capacity to retain radiator coolant overflow, as per rule 25.18(b).</b>
Exhaust system	20.1 20.2 20.3  20.4 20.5 20.6 20.7 20.8 20.9 20.10 20.11	<p>Must be as supplied by BRP-POWERTRAIN and cannot be modified except for the replacement of the silencer absorption material and the use of threaded fasteners in place of the rivets for securing the silencer end cap. Standard exhaust socket must be used.</p> <p>Exhaust pipe with after muffler as shown in illustrations.</p> <p>Both versions (version with welded on after muffler and version with after muffler fixed by 2 springs) are legal to be used.</p> <div style="text-align: center;">  </div> <p>Diameter of hole of end cap of (pos 6, illustration above): Max. 21,0 mm.</p> <p>Length of inlet cone: 592 mm +/-5 mm (measured on outside from beginning of exhaust pipe until beginning of cylindrical part).</p> <p>Length of cylindrical part of exhaust pipe: 125 mm +/-5 mm.</p> <p>Length of end cone: 225 mm, +/-5 mm</p> <p>Outside diameter of 180° bent tube: 41mm +1,5 mm/-1,0 mm (measured at beginning and end of bend).</p> <p>Just one piece of original isolating mat is allowed to be used. The original exhaust system (tuned pipe and silencer) may not be modified</p> <p>For measuring the exhaust gas temperature, it is allowed to weld on a socket on top of the exhaust, 50 mm from the ball joint.</p> <p>The use of a maximum 4 pieces of exhaust springs to fix the exhaust to the cylinder, are allowed.</p>
Noise emissions	21.1	Noise isolating mat (see illustration exhaust system) has to be replaced by a original BRP-POWERTRAIN spare part,